

ecodut K2/K1 LED

Ecodut K2 y K1 con un diseño renovado, clásico e innovador se adapta perfectamente al ambiente urbano y vial, proporcionando los últimos avances tecnológicos del mercado de la mano del departamento de I+D de Secom Iluminación.

Incorpora la última generación de semiconductores LED Osram Oslon SSL, el cual permite adaptarse perfectamente con distintas fotometrías a las necesidades de cada instalación. Sin contaminación lumínica para la protección de la calidad del cielo nocturno, categoría E1.

De fácil instalación sin necesidad de abrir la luminaria y sin apenas mantenimiento debido a su robustez, incluye protección individual para cada uno de los LED. Elegante diseño optimizado para favorecer la evacuación de temperatura y la eliminación de suciedad. Opcionalmente control de temperatura NTC.

En cumplimiento estricto de la normativa vigente, Secom Iluminación ofrece sistemas de regulación adecuados para cada instalación, consiguiendo ahorros adicionales en el consumo energético y facilitando la movilidad de los ciudadanos y vehículos en condiciones de confort y máxima seguridad sin renunciar a las prestaciones lumínicas.

Disponible sensor de movimiento integrado (Ref. DMR8) para adaptar el flujo lumínico en función del tránsito de viandantes. Regulación en cabecera de la tensión de red (Ref. RC) o regulación autónoma (DN/DRP) que permite a la luminaria hacer regulación en instalaciones en las cuales no existe ningún sistema de regulación.

Compatible con sistemas de telegestión inteligente para iluminación por radiofrecuencia o PLC permitiendo control punto a punto y la monitorización a tiempo real de cada luminaria para un control total, también disponibles sistemas más económicos de telegestión que incluyen monitorización a nivel de cuadro de mando.

Ecodut K2 no solo trata de iluminar sino de facilitar la movilidad de los ciudadanos en condiciones de confort y máxima seguridad, que los ciudadanos disfruten del paisaje urbano, ayudar a sentirse más comfortable en la ciudad, en definitiva de esta manera proporcionar una mejor calidad de vida de las personas.

Ecodut K2 and K1 with a renewed, classic and innovative design is perfectly suited to the urban and street environment of the city providing the latest technology of the market thanks to Secom's R&D.

Incorporates the latest generation of semiconductor Osram Oslon SSL LED, which can be adapted perfectly to different photometric needs of each installation. No light pollution to protect the quality of the night sky, E1 category.

Easy installation without opening the fixture and without hardly maintenance due to its robustness, includes individual protection for each LED. Elegant design optimized to facilitate the evacuation of temperature and soil removal. Optionally NTC temperature control.

In strict compliance with current regulations, Secom Lighting offers appropriate regulatory systems for each facility, getting additional savings in energy consumption and facilitating the mobility of citizens and vehicles in terms of comfort and maximum safety without compromising on lighting performance.

Available integrated motion sensor (Ref. DM8MOV) to adjust the lighting depending on the traffic flow of pedestrians. Header regulation voltage (Ref. CR) or autonomous regulation (DN / DRP) that allows the regulation of the luminaire in installations where it doesn't exist.

Compatible with intelligent remote management systems for lighting by radio or PLC, allowing control point to point and real time monitoring of each luminaire for total control, also available cheaper remote control systems including level monitoring dashboard.

Ecodut K2 is not only illuminating, it is facilitating the mobility of citizens in conditions of maximum comfort and security, that citizens enjoy the cityscape, helping you to feel more comfortable in the city, thus ultimately provide better quality of life of people.



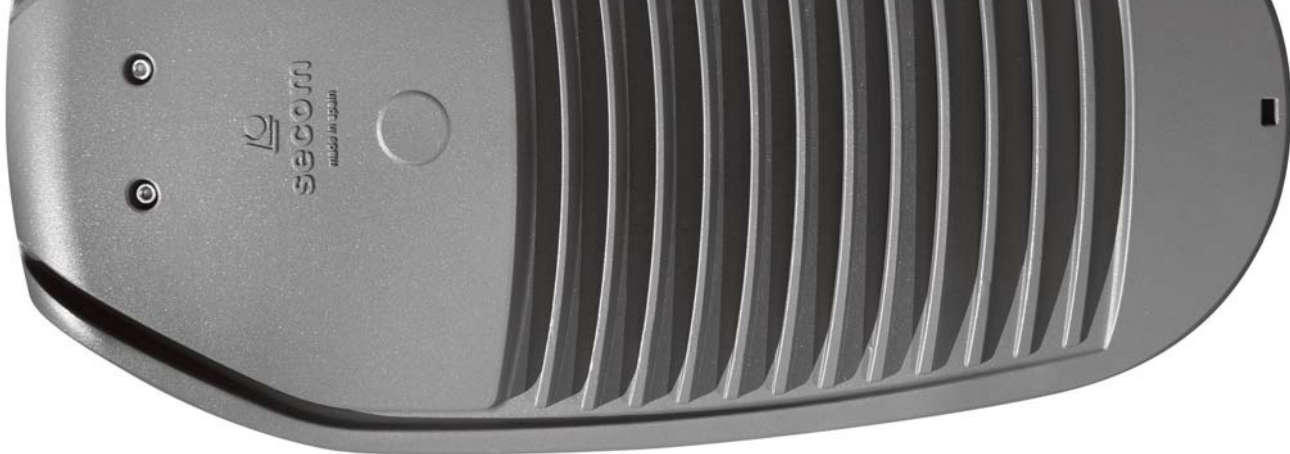

ecodut K2 / LED



Ecodut K2 LED - Óptica simétrica 150°
Ecodut K2 LED - Symmetric optics 150°



Incluye driver y lámparas LED
Includes driver and LED lamps

Ref.	Colour / Colour	Lumens	W
3370 58 30 85	Gris / Gray	4536	30W
3370 58 50 85	Gris / Gray	6480	50W
3370 58 70 85	Gris / Gray	9072	70W
3370 58 10 85	Gris / Gray	14256	100W
3370 58 15 85	Gris / Gray	21384	150W
3370 58 20 85	Gris / Gray	28512	200W

* Se suministra de manera estándar con lámpara 5700°K.
* Standardly supplied with 5700°K LED lamp.

Grado de protección / Protection degree / IP66
índice de protección antivandálico / Impact protection index / Ik09

OPCIONES / OPTIONS

Driver / Driver

Ref. DR	Driver regulable 1 - 10v / Dimmable driver 1 - 10v
Ref. DRD	Driver regulable Dali / Dimmable driver Dali
Ref. DRP	Driver programable / Programmable driver
Ref. DRPNTC	Driver prog. y sonda T° NTC / Prog. driver & NTC control
Ref. DN	Regulación doble nivel / Double level dimmable
Ref. DRC	Regulación en cabecera / Regulation at the head
Ref. DMR8	Regulación de movimiento / Motion detector
Ref. 4160	Driver para funcionam. a 12Vdc. / Driver for 12Vdc operation

Accesorios / Accessories

Ref. IK10	Índice de protección antivandálico / Impact protection index
Ref. II	Clase II / Class II
Ref. AM	Pintura especial ambiente marino / Special marine environment paint
Ref. 3390	Protector de sobretensión / Surge protector
Ref. 6033	Raco adaptador de 60 mm. a 33 mm. / Reducing adapter from 60mm. to 33mm.
Ref. 6048	Raco adaptador de 60 mm. a 48 mm. / Reducing adapter from 60mm. to 48mm.
Ref. 6076	Raco adaptador de 60 mm. a 76 mm. / Reducing adapter from 60mm. to 76mm.

Ópticas / Optics

Ref. 3408	Óptica simétrica 80° / Symmetric optics 80°
Ref. 3407	Óptica asimétrica 150° / Asymmetric optics 150°
Ref. 3407 3408	Óptica asimétrica 80° / Asymmetric optics 80°
Ref. 3405	Óptica asimétrica Street / Asymmetric optics Street
Ref. AMB	LED Ámbar / Amber LED

OPCIONES LED / OPTIONS LED

	Ref. AMB	Ref. 83	Ref. 84	Ref. 85
CRI>80 / Temp. de color / Colour temperature	Ámbar/Amber	3000°K	4000°K	5700°K
Lum 30w	2744	3780	4133	4536
Lum 50w	3920	5400	5904	6480
Lum 70w	5488	7560	8266	9072
Lum 100w	8232	11880	12989	14256
Lum 150w	12544	17820	19484	21384
Lum 200w	20384	23760	25978	28512

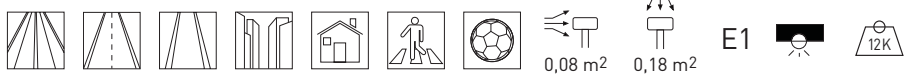



ecodut K1 LED



Ecodut K1 LED - Óptica simétrica 150°
Ecodut K1 LED - Symmetric optics 150°



Incluye driver y lámparas LED
Includes driver and LED lamps

Ref.	Colour / Colour	Lumens	W
3380 58 25 85	Gris / Gray	3888	25W
3380 58 50 85	Gris / Gray	7128	50W
3380 58 75 85	Gris / Gray	10368	75W

* Se suministra de manera estándar con lámpara 5700°K.
* Standardly supplied with 5700°K LED lamp.

Grado de protección / Protection degree / IP66
Índice de protección antivandálico / Impact protection index / Ik09

OPCIONES / OPTIONS

Driver / Driver

Ref. DR	Driver regulable 1 - 10v / Dimmable driver 1 - 10v
Ref. DRD	Driver regulable Dali / Dimmable driver Dali
Ref. DRP	Driver programable / Programmable driver
Ref. DRPNTC	Driver prog. y sonda T° NTC / Prog. driver & NTC control
Ref. DN	Regulación doble nivel / Double level dimmable
Ref. DRC	Regulación en cabecera / Regulation at the head
Ref. DMR8	Regulación de movimiento / Motion detector
Ref. 4160	Driver para funcionam. a 12Vdc. / Driver for 12Vdc operation

Accesorios / Accessories

Ref. IK10	Índice de protección antivandálico / Impact protection index
Ref. II	Clase II / Class II
Ref. AM	Pintura especial ambiente marino / Special marine environment paint
Ref. 3390	Protector de sobretensión / Surge protector
Ref. 6033	Raco adaptador de 60 mm. a 33 mm. / Reducing adapter from 60mm. to 33mm.
Ref. 6048	Raco adaptador de 60 mm. a 48 mm. / Reducing adapter from 60mm. to 48mm.
Ref. 6076	Raco adaptador de 60 mm. a 76 mm. / Reducing adapter from 60mm. to 76mm.

Ópticas / Optics

Ref. 3408	Óptica simétrica 80° / Symmetric optics 80°
Ref. 3407	Óptica asimétrica 150° / Asymmetric optics 150°
Ref. 3407 3408	Óptica asimétrica 80° / Asymmetric optics 80°
Ref. 3405	Óptica asimétrica Street / Asymmetric optics Street
Ref. AMB	LED Ámbar / Amber LED

OPCIONES LED / OPTIONS LED

CRI>70 / Temp. de color / Colour temperature	Ref. AMB Ámbar/Amber	Ref. 83 3000°K	Ref. 84 4000°K	Ref. 85 5700°K
Lum 25w	2352	3240	3543	3888
Lum 50w	4312	5940	6495	7128
Lum 75w	6272	8640	9447	10368





ecodut K2/LED

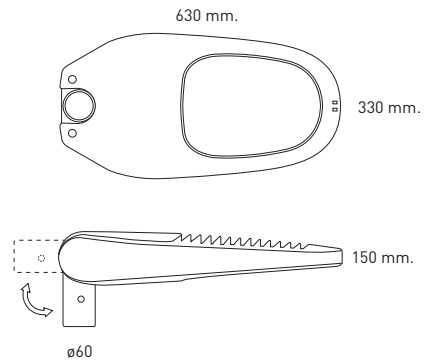

ecodut K1/LED

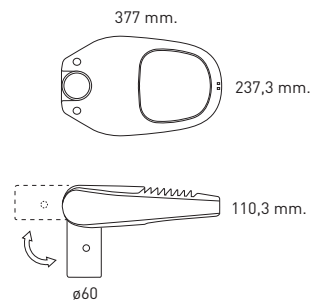

ecodut K2/K1/LED

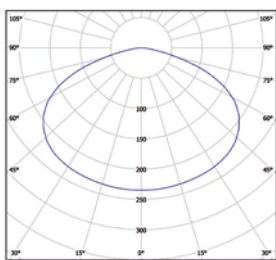

Óptica simétrica de 150°
Symmetric optical 150°

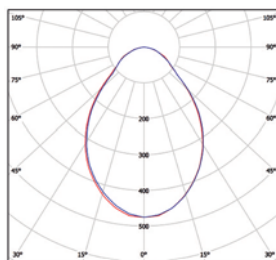

Ref. 3408 Óptica simétrica de 80°
Symmetric optical 80°

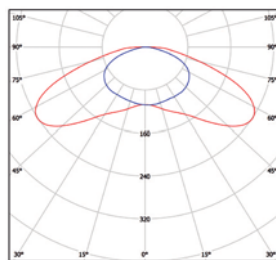

Ref. 3407 Óptica asimétrica de 150°
Asymmetric optical 150°

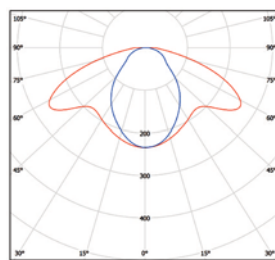

Ref. 3408 3407 Óptica asimétrica de 80°
Asymmetric optical 80°

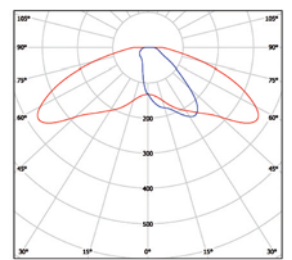

Ref. 3405 Óptica asimétrica Street
Asymmetric optical Street

Los beneficios de las luminarias de LEDs de secom.

Ahorro energético por su alta eficiencia.
Ahorro en mantenimiento de luminarias.
Reproducción cromática (IRC) 80.
Amplia gama en temperaturas de color.
Amplia gama de medidas y de colores.
Posibilidad de regular las luminarias.
Ópticas de alto rendimiento.
Fácil montaje e instalación.

¿Por qué trabajar con secom?

Fabricación nacional de todas sus luminarias de LEDs.
Disponibilidad de todos los componentes de las luminarias de LEDs (disipadores, LEDs, circuitos, drivers, etc) para reposición.
El mejor servicio en luminarias de LEDs, debido a la fabricación nacional y al gran stocks de componentes.
Gran versatilidad en diseño, posibilidad de personalizar luminarias.
Productos que cumplen la normativa europea vigente.
Componentes Osram Duris E5.
Estricto control de calidad.
Gran inversión en I+D+i para el desarrollo de flujos lumínicos y tecnologías de disipación de temperatura.
PCB con fechador para verificar la vida media útil garantizada.

The benefits of secom LED lighting fittings.

Energy-saving because of his high efficiency.
Saving in maintenance.
Cromatic reproduction (ICR) 80.
Wide range of colour temperature.
Wide range of measures and colours.
Possibility of dimming the lighting fitting.
High output optics.
Easy installation.

Why should you work with secom?

Own production of all our LED light fitting.
Availability of all components of LEDs fittings (heat sink, LEDs, drivers, etc.) for replacement.
The best service in the LEDs fitting due to the production in our own production plants of and a large stock of components.
Flexibility in design and possibility of customize the fittings.
The products comply with European standards.
Components are Osram Duris E5.
Strict quality control.
Big investment in R&D on development of luminus fluxes and temperature dissipation technologies.
PCB with its production date for life span control.

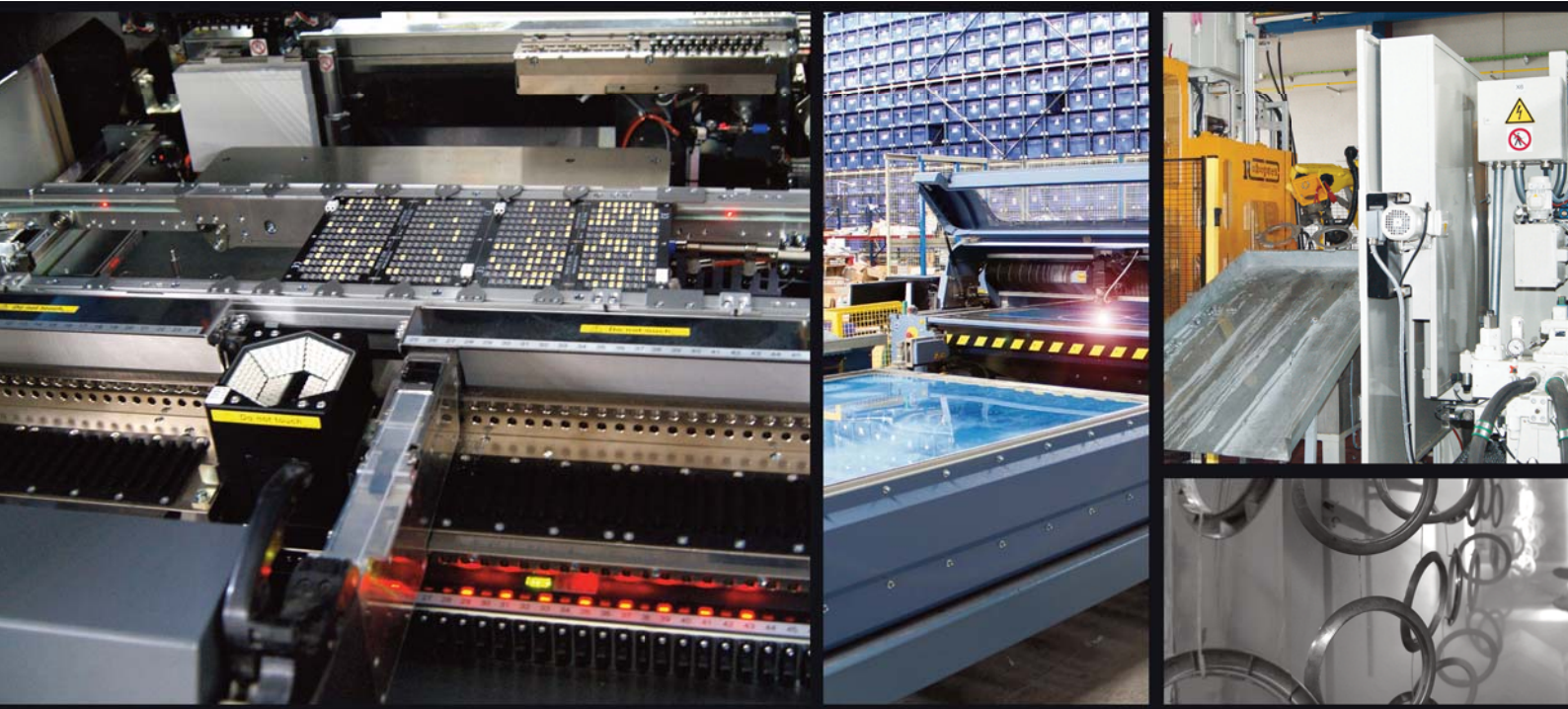

secom
here comes the light

Polígono Industrial la Estrella. C/ Marte 18-21
0500 Molina de Segura (Murcia) Spain - Buzón de correos nº11
Tlf.: 968 80 12 11 - Fax.:968 89 10 48 - secom@secom.es
Dpto.Exportación. Tlf.: ++34-968-80 18 00. Fax.: ++34-968-89 10 48
export@secom.es



www.secom.es

